

| | | | |
|------|-------------------|---------|---------|
| REV. | 移动焊脚位由9.95改为10.15 | PENTIUM | 0403'10 |
|------|-------------------|---------|---------|

NOTES:

- MATERIAL:
 HOUSING: HIGH TEMPERATURE THERMOPLASTIC
 UL94V_0,COLOR:BLACK.
 CONTACT: COPPER ALLOYS.
 COVER: COPPER ALLOYS OR STEEL.
- PLATING:
 UNDERPLATE: NICKEL.
 CONTACT AREA: GOLD OVER NICKEL.
 SOLDER AREA: TIN OVER NICKEL.
- MULTIMEDIA CARD COMPATIBLE

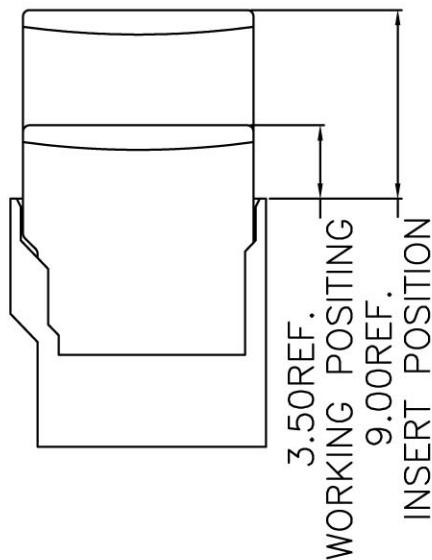
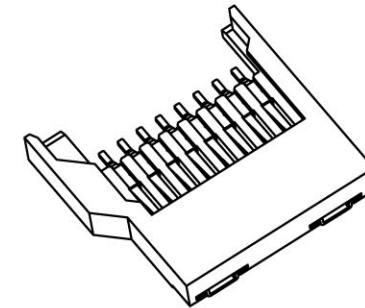
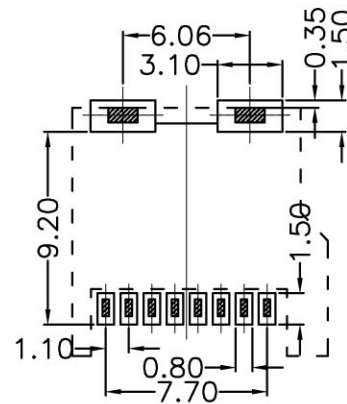
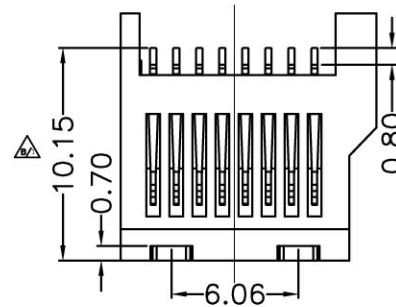
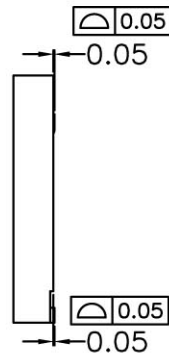
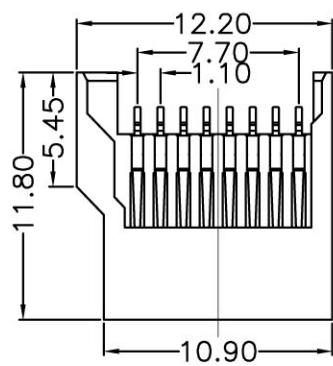
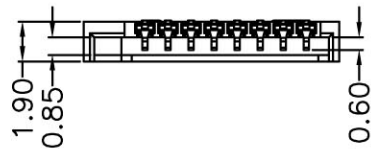

RECOMMENDED P.C.B HOLE LAYOUT
 COMPONENT SIDE VIEW(TOLERANCE: +/-0.05)

| | | | | | |
|---|----------|---|--|---------------------------|----------|
| PART NO: | | MATERIAL: | | 深圳市迈瑞康电子有限公司 | |
| LOT NO: 100100100X | | FINISH: | | | |
| UNIT: MM | SIZE: A4 | COLOR: | | TITLE: | |
| TOLERANCES: X.X=±0.35 X.XX=±0.25 X.XXX=±0.15 | | GENERAL ANGLE: X.X=±5.0° X.XX=±3.0° | | T-FLASH简易全塑卡座 | |
| DR: 杨凯 082708 | | CHK: | | DWG NO: MRK-TF04-180-0000 | REV: B/1 |
| APP: | | SCALE: 1:1 | | SHEET: 1 OF 3 | |