

NOTES:

- MATERIAL:
HOUSING: HIGH TEMPERATURE THERMOPLASTIC
UL94V_0,COLOR:WHITE.
CONTACT: COPPER ALLOYS.
COVER: SPTE.
- PLATING:
UNDERPLATE: NICKEL.
CONTACT AREA: GOLD OVER NICKEL.
SOLDER AREA: TIN OVER NICKEL.
- MULTIMEDIA CARD COMPATIBLE

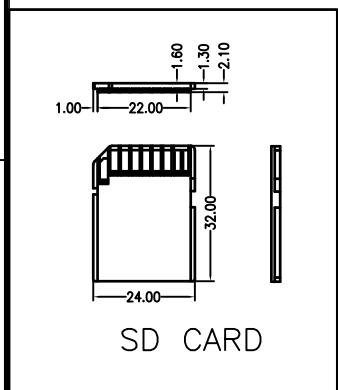

PART NO:		MATERIAL:		<h1 style="margin: 0;">深圳市迈瑞康电子有限公司</h1>
LOT NO:		FINSH:		
UNIT: MM	SIZE: A4	COLOR:		
TOLERANCES: X.X=±0.15 X.XX=±0.05 X.XXX=±0.03		GENERAL ANGLE: X.X=±1.0° X.XX=±0.5°		TITLE: SD短卡 铜壳
DR: 杨凯 2011/03/31		CHK:		DWG NO: MRK-SD22-290-0005
APP:		SCALE: 1:1		REV: A/0
		SHEET: 1 OF 1		

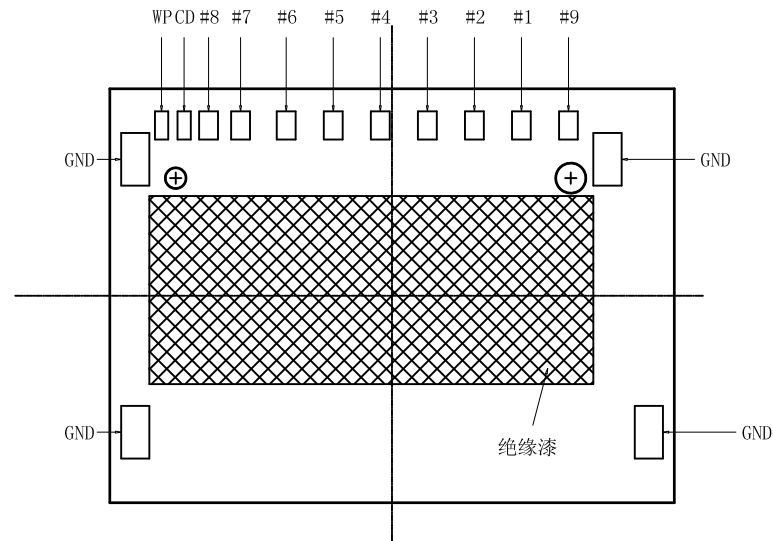
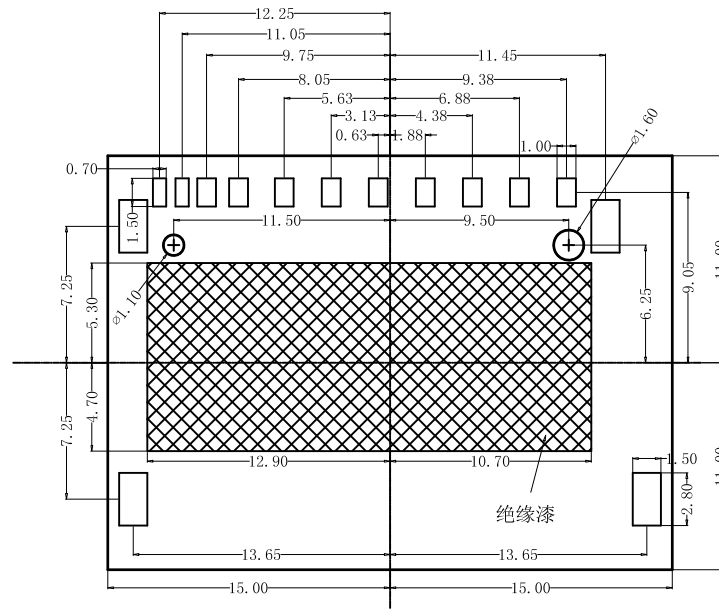

P.C.B LAYOUT
(TOLERANCE: ±0.05)

PIN NO.	NAME	DESCRIPTION
1#	CD/DAT3	CARD DETECT
2#	CMD	COMMAND
3#	VSS1	GROUND
4#	VDD	POWEER
5#	CLK	CLACK
6#	VSS2	GROUND
7#	DAT0	DATE I/O
8#	DAT1	DATE I/O
9#	DAT2	DATE I/O

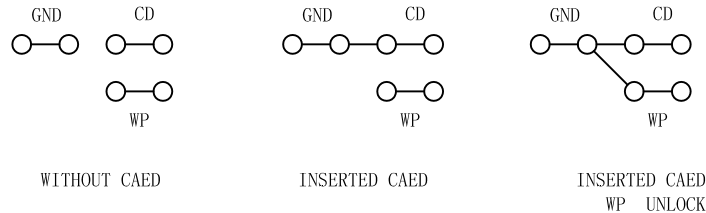

PART NO:		MATERIAL:		深圳市迈瑞康电子有限公司		
LOT NO:		FINSH:				
UNIT: MM	SIZE: A4	COLOR:		TITLE: SD短卡 铜壳		
TOLERANCES: X.X=±0.15 X.XX=±0.05 X.XXX=±0.03		GENERAL ANGLE: X.X=±1.0° X.XX=±0.5°		DR: 杨凯 2011/03/31	DWG NO: MRK-SD22-290-0005 SCALE: 1:1	
				CHK:		REV: A/0
				APP:		SHEET: 1 OF 1

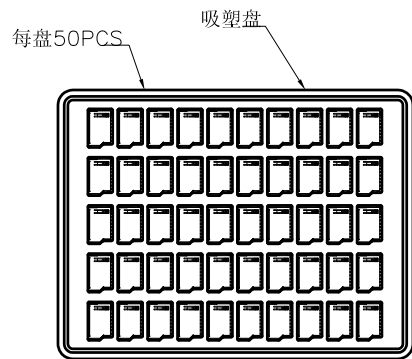

每盘50PCS

吸塑盘

吸塑盘规格:

NO. 1

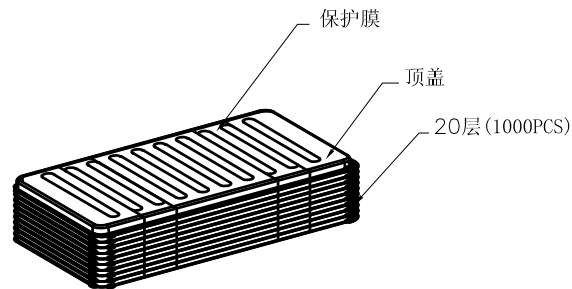

保护膜

顶盖

20层(1000PCS)

NO. 2

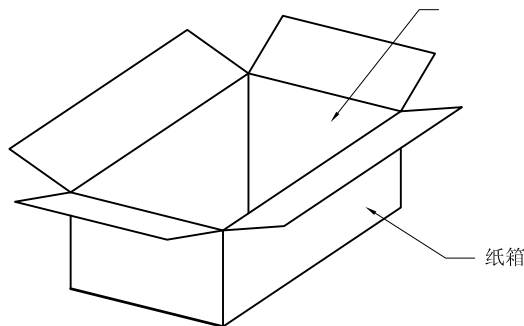

纸箱

NO. 3

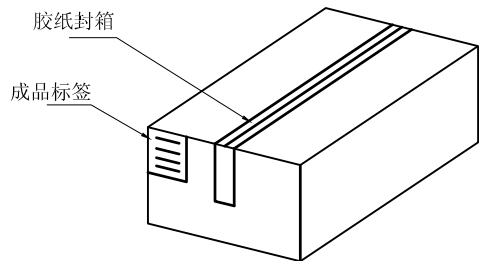

胶纸封箱

成品标签

NO. 4

1. 材质要求:
 - 1.1 纸箱的材质为A-B; 外形尺寸为42*27*37CM;
 - 1.2 PS盘的材质为PS, PS盘的外形尺寸265*190*10MM;
2. 包装要求:
 - 2.1 每一盘装50PCS;
 - 2.2 每20盘累叠在一起, 共计1Kset; 上面需放一个空盘, 后用PE膜缠绕;
 - 2.3 每 Kset装一个纸箱;
 - 2.4 把包装好的成品打包封箱, 并在纸箱上贴物料标签;

PART NO:		MATERIAL:		深圳市迈瑞康电子有限公司	
LOT NO:		FINSH:			
UNIT: MM	SIZE: A4	COLOR:		TITLE: SD短卡 铜壳	
TOLERANCES: X.X=±0.35 X.XX=±0.25 X.XXX=±0.15		GENERAL ANGLE: X.X=±5.0° X.XX=±3.0°		DR: 杨凯 2011/03/31	DWG NO: MRK-SD22-290-0005
APP:		CHK:		REV: A/0	SCALE: 1:1
				SHEET: 3 OF 3	