

REV.	ECN.NO.	MODIFY.CONTENT	DATE

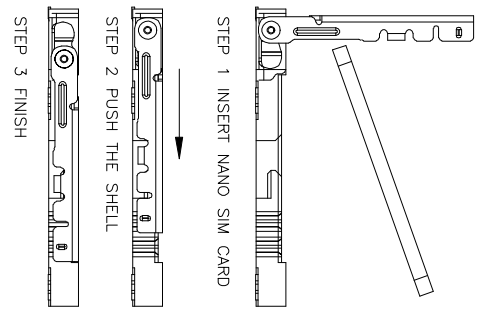

NOTES:

- MATERIAL:**
 - Housing: High Temperature Thermoplastic UL94V-0; Color Black.
 - Terminal: Copper Alloy, T=0.12mm.
 - Shell: Stainless Steel; T=0.20mm.
- FINISH:**
 - Terminal: Plated Gold on the Contact Area and Solder Tails
 - Peg: Plated Gold on the Solder Tails.
- SPECIALTY:**
 - Rated current: 0.5A
 - Rated voltage: 50V
 - Contact Resistance: 50mΩ MAX
 - Insulation Resistance: 100MΩ MIN 100V DC
 - Dielectric withstanding voltage: 100V AC.
 - Solder ability: 245±5°C, 5±0.5s.
 - Operating condition: Temperature: -30°C~+80°C Humidity: 80% R.H MAX

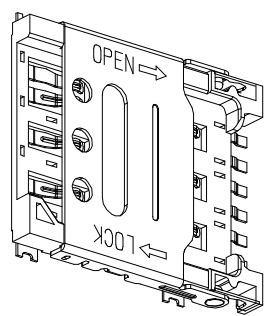
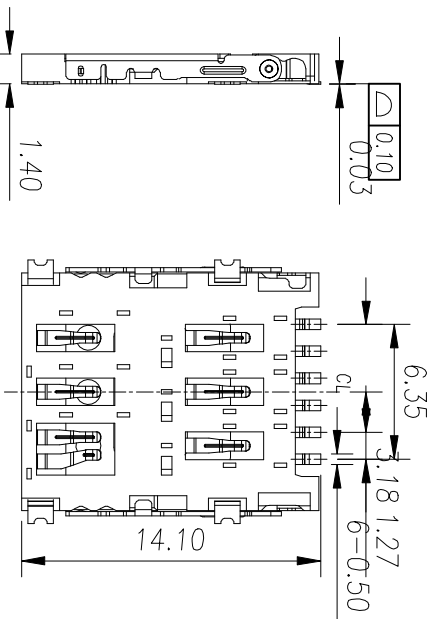
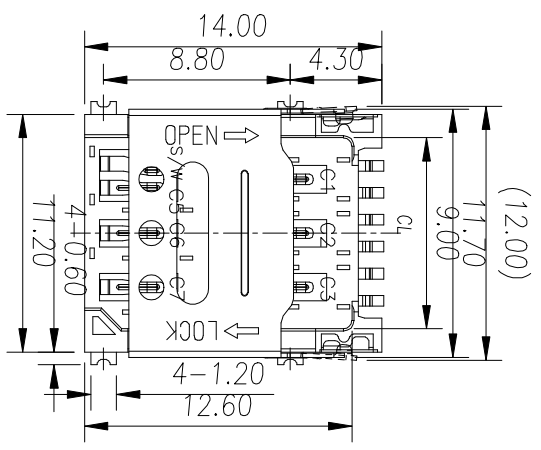
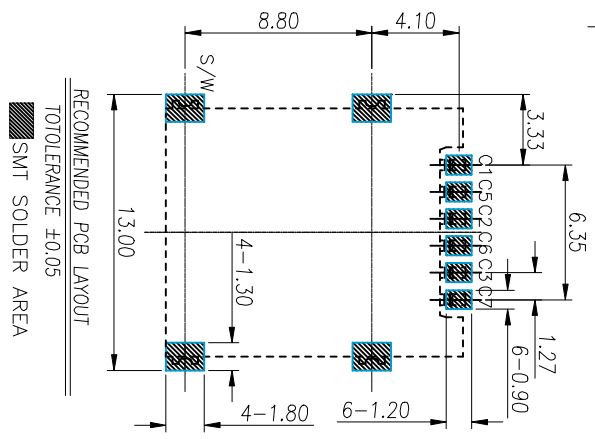

PIN NO.	PIN NAME
C1	VCC
C2	RST
C3	CLK
C5	GND
C6	VPP
C7	I/O
S/W	Switch Pin

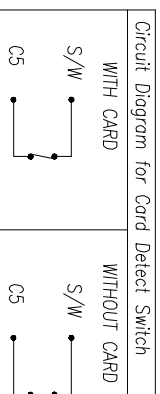
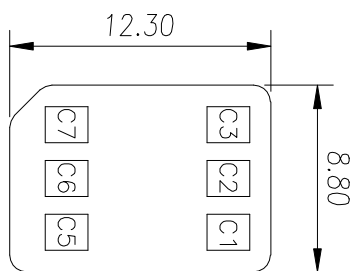

GENERAL TOLERANCE		圖號	品名	規格	日期	比例
X.±0.35	X.±5°	1.4H	NANO SIM CARD			1:1
.X±0.30	.X±2°	HINGE TYPE				mm
.XX±0.25	.XX±1°	料號	MRK-SM01-140-0009	2015/12/15		mm
.XXX±0.15	.xxx±0.5°	頁數	1/1			mm

深圳市迈睿康科技有限公司